

# Decorative Curtain Poles





## Hand Operated Curtain Pole System

# Silent Gliss® 6140M Metropole 50mm

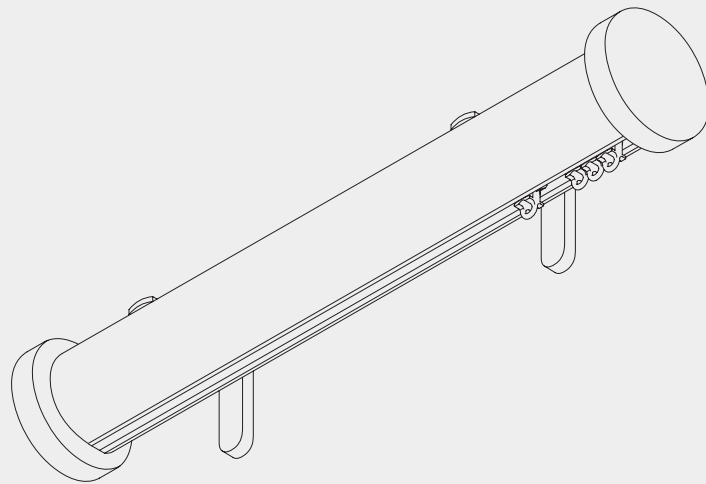

### Product Information

- Hand operated system for domestic and contract applications.
- Can be bent for bay windows.
- Choice of 7 different finishes - black, white, steel grey, diva gold, silver and wood effects; mahogany and oak.
- Accessorised with matching end caps and co-ordinated or matching brackets/bracket covers.
- A selection of finials are available.
- Easy fitting to wall with adjustable brackets.
- For medium to heavy curtains.
- Suitable for use with Wave Standard and Wave XL curtain heading system.
- Profile length 6m (wood effect 5m).



6140M

## Profile and Bending Information

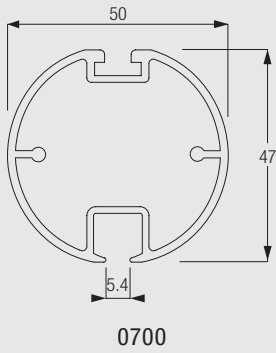

**Note:** It is important to observe the minimum bending radius for Wave XL. The system will not function with a smaller radius.

**Specification Guide - download [www.silentgliss.co.uk](http://www.silentgliss.co.uk) (password required)**

Silent Gliss 6140M curtain track, hand drawn, aluminium, assembled complete with gliders 6143 at 10/m and 2 endcovers 0714. Face fix with bracket 0537 each screwed to timber /plugged and screwed to block-work/concrete at 600mm centres. Finished in black, white, steel grey, diva gold, silver and wood effects honey maple or mahogany.

## How To Measure

### Stack size calculation Wave XL

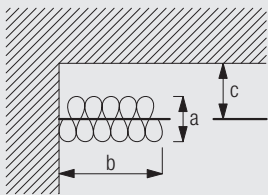

a = Stack depth 35cm  
b = Stack size  
c = Min. distance 22cm

System width		77-107	108-143	144-179	180-215	216-251	252-287	288-323	324-359	360-395
	b	21	26	31	36	41	46	51	56	61
System width		396-431	432-468	469-503	504-539	540-575	576-600			
	b	66	71	76	81	86	91			
System width		154-217	218-289	290-361	362-433	434-505	506-577	578-600		
	b	21	26	31	36	41	46	51		

(dimensions in cm)

6140M

## Design Options

### Finials

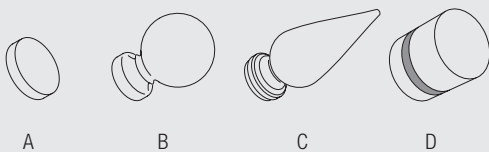

Finials are decorative elements that fit on at the end of the pole.

A: 0714 Matching endcaps  
B: 0717 Ball End 125mm  
C: 0718 Real Wood Spear 150mm  
D: 0697 Strata 65mm

All finials are made of real wood.

### Midials

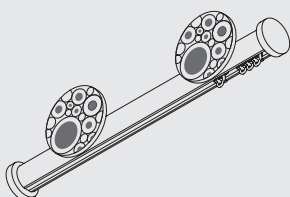

Midials are a curtain pole decoration projecting in front of the pole.

Please refer to the specific Metropole brochure for more detail and colour descriptions.

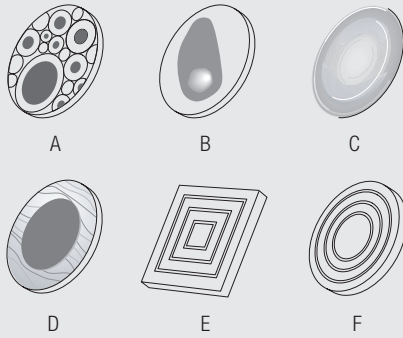

- A: M1 Bamboo Disc (90mm)
- B: M2 Mother of Pearl Disc (90mm)
- C: M4 Discuss Glass (100mm - red, white purple, lilac)
- D: M7 Wood/Leather Disc (100mm - oak, walnut)
- E: M8 Vega Square 80mm
- F: M9 Vega Circle 80mm

## Holdbacks

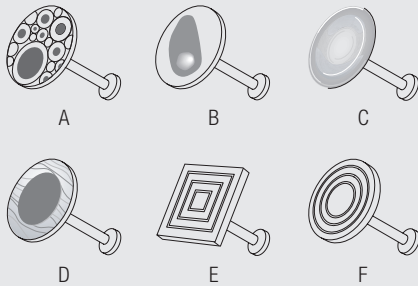

Midial designs can be used on matching holdback arms.

Please refer to the specific Metropole brochure for more detailed information and colour descriptions.

- A: HB1 Bamboo Disc 90mm
- B: HB2 Mother of Pearl Disc 90mm
- C: HB4 Discus Glass (Red, white, amber, purple, lilac) 100mm
- D: HB7 Wood/Leather Disc (oak/walnut) 100mm
- E: HB8 Vega Square 80mm
- F: HB9 Vega Circle 80mm

## Wave Standard curtain heading system

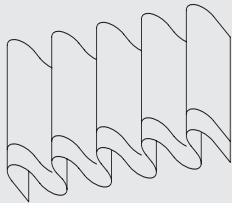

Wave is an exciting new contemporary curtain heading system which allows curtains to hang in a continuous wave which is smooth, simple and elegant.

When using the Wave curtain heading system please note the maximum recommended curtain weight is 2.5kg/m.



6140M

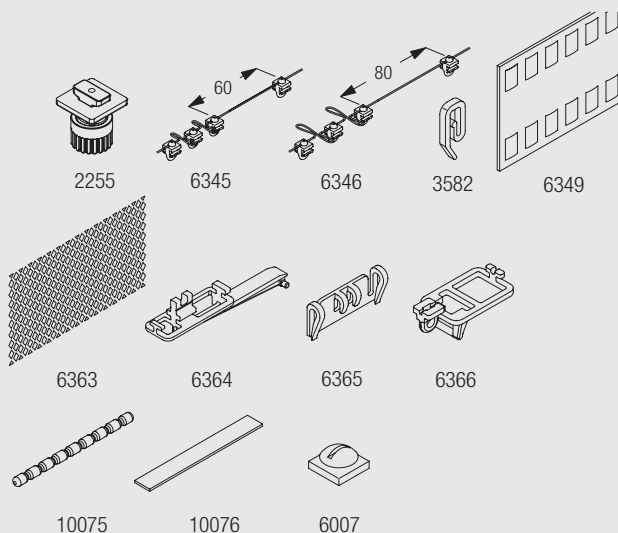

The Wave standard components are:

- 2255 Adjustable brake
- 6345 Glider Cord 60mm
- 6346 Glider Cord 80mm
- 3582 Hook
- 6349 Curtain tape
- 6363 Iron-on top hemming tape
- 6007 End stop

Additional optional Wave components:

- 6364 Extension (for use with 6365)
- 6365 Hanger (for use with 6364)
- 6366 Carrier for draw rod
- 10075 Lead weight for bottom hem 50gr/m
- 10076 Fabric weight for side of curtain

## Wave XL curtain heading system

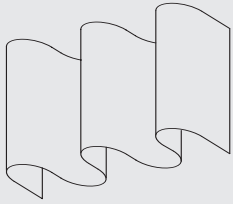

Wave XL is especially designed for high and large application areas through generously designed waves with large cross section dimensions.

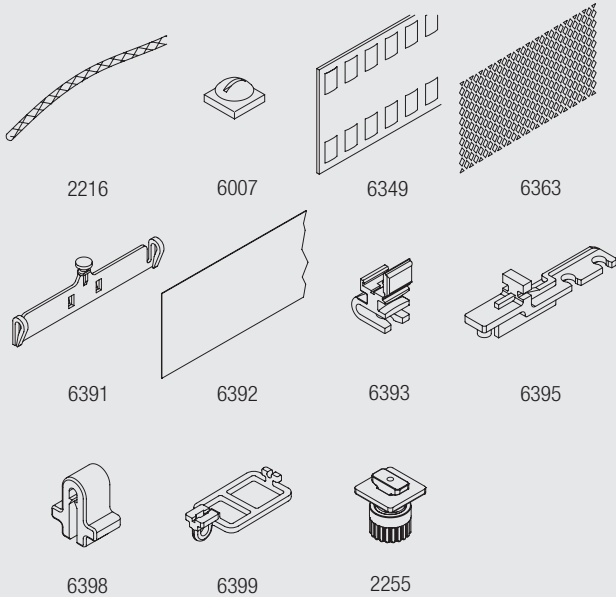

The Wave XL components are:

- 2216 Cord 0.85 mm
- 2255 Adjustable brake
- 6007 End stop
- 6349 Curtain tape
- 6363 Iron tape
- 6391 Hanger
- 6392 Heading film
- 6393 Glider
- 6395 Extension
- 6398 Clip
- 6399 Carrier for draw rod

## Fitting Information



### Bracket positioning when using adjustable brackets 0537

6140M

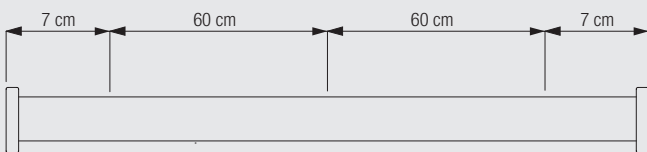

Note: If using 0731 Vela brackets spacing increases to 1 bracket per metre starting 7cm in from each end.

### Fitting of track to bracket

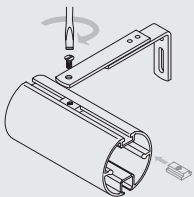

Using adjustable bracket 0537.

## Fitting Options

### Wall fix with adjustable brackets 0537

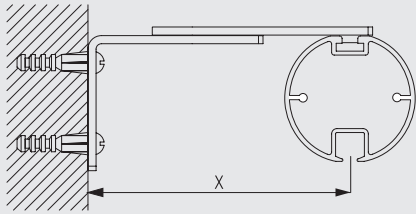

	X (mm)
0537	80-100

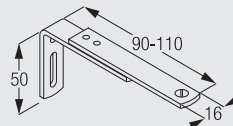

0537  
Adjustable bracket

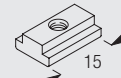

6141  
Track insert (uses screw 6784)

### Wall fix with brackets 3134/2-3136/2

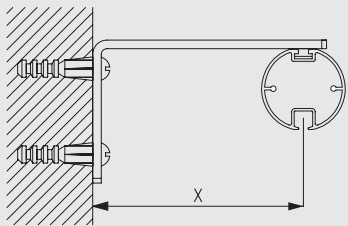

	X (mm)
3134/2	52
3135/2	72
3136/2	92

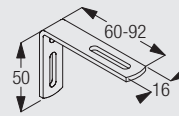

3134/b  
Midial ceiling fix bracket

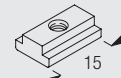

6141  
Track insert (uses screw 6784)

### Wall fix with ultra brackets 6133 and 6134

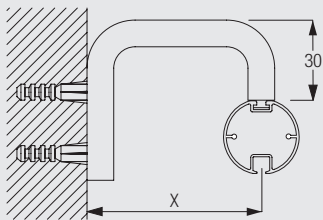

	X (mm)
6133	65
6134	115

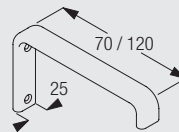

6133-34  
Ultra brackets

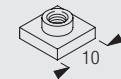

6117  
Track insert

### Wall fix with Vela bracket

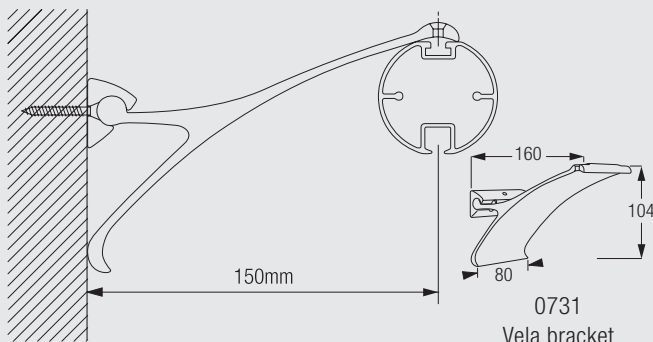

0731  
Vela bracket

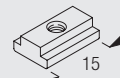

6141  
Track insert (uses screw 6784)



6140M

## Ceiling fix with 6138P2

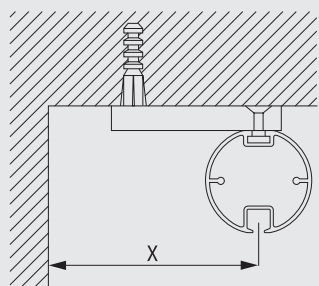

X (mm)  
80-100

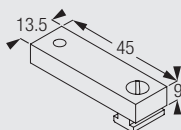







6138P2  
Ceiling support set

Min. distance from wall when using Wave XL: 220mm.

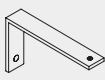
## Standard Accessories

0537	Adjustable bracket		0700	Profile 50mm	
0714	End cap 50mm		3133	Bracket cover (60mm)	
6065	Twist eye endstop		6141	Track insert (uses screw 6784)	
6143	Glider 6144 in strip form		6784	Machine screw (for 6141 insert)	

## Optional Accessories

6140M	0697	Strata hand (50mm)		0713	Midial connecting bracket	
	0717	Ball end finial (50mm pole)		0718	Spear finial (50mm pole)	
	0731	Vela bracket		HB1	Bamboo holdback	
	HB2	Mother-of-pearl holdback		HB4	Glass discus holdback	
	HB7	Leather woodend holdback		HB8	Vega square holdback	
	HB9	Vega circle holdback		M1	Bamboo disc midial	
	M2	Mother of pearl midial		M3	Veneer disc midial	
	M4	Glass discus midial		M7	Wood/leather discus midial	

M8	Vega square midial		M9	Vega circle midial	
2216	Cord		2255	Adjustable brake	
3582	Hook		6007	Endstop	
6007	Endstop		6133	Ultra bracket (70mm)	
6134	Ultra bracket (120mm)		6283	Roller glider	
6345	Wave glider cord (60mm)		6346	Wave glider cord (80mm)	
6349	Wave curtain heading tape		6363	Top hemming tape	
6364	Extension		6365	Hanger	
6366	Carrier for draw rod		6391	Hanger	
6392	Heading film		6393	Glider	
6394	Carrier		6395	Extension	
6398	Clip		6399	Carrier for Draw rod	
10075	Lead weight 50 gr/m		10076	Fabric weight	
3134/2	Pole extension bracket (60mm - all colours)		3134/b	Midial ceiling fix bracket	
3135/2	Pole extension bracket (80mm - all colours)		3136/2	Pole extension bracket (100mm - all colours)	
6138P2	Ceiling support set				

6140M



6140M



6140M

[www.silentgliss.co.uk](http://www.silentgliss.co.uk)

Silent Gliss Ltd  
Pyramid Business Park  
Poorhole Lane  
Broadstairs  
Kent  
CT10 2PT  
Great Britain

Tel: 0044 (0) 1843 863571  
Fax: 0044 (0) 1843 864503  
[sales@silentgliss.co.uk](mailto:sales@silentgliss.co.uk)